

MONATM

Owner's Manual Version 1.0 for Mac

Mona is designed and manufactured in the U.S. by Echo Corporation

Important Safety Instructions

- 1. Read Instructions** - Be sure to read all of the safety and operating instructions before operating this product.
- 2. Retain Instructions** - The safety instructions and owner's manual should be retained for future reference.
- 3. Heed Warnings** - All warnings on Mona and in the Owner's Manual should be followed.
- 4. Follow Instructions** - All operating and use instructions should be followed.
- 5. Moisture** - Water and moisture are detrimental to the continued good health of Mona. Do not install or operate Mona near sources of water or moisture such as sinks, damp basements, leaky roofs, etc.
- 6. Heat** – Mona should be situated away from sources of heat such as heaters or radiators.
- 7. Power Sources** - This unit should be operated only from the type of power source indicated in this documentation or on Mona. If you are unsure about the type of power at your location, contact your local power company.
- 8. Grounding** - Precautions should be taken so that the grounding capabilities of the Mona unit are not undermined. This equipment is provided with a cord having an equipment grounding conductor and grounding plug. This plug must be plugged into an outlet that is properly installed and grounded in accordance with all local rules and ordinances. Do not modify the plug provided with the equipment. If the plug will not fit into your outlet, have a proper outlet installed by a qualified electrician.
- 9. Power Cord Protection** - Power supply cords should be routed so that they are unlikely to be walked on or pinched by items placed upon or against them. Pay particular attention to protecting the plugs, outlets, and the point at which the cord exits Mona.

10. Servicing - Do not attempt to service this unit yourself, as opening the case will expose you to hazardous voltage or other dangers. All servicing should be referred to qualified service personnel.

11. Damage Requiring Service - Unplug this unit and refer it to a qualified service technician when any of the following occur:

- a) Objects have fallen or liquid has spilled into the unit
- b) The product has been exposed to rain or water
- c) The product does not operate normally or when a marked change in performance is noticed
- d) The product has been dropped or damaged in any way

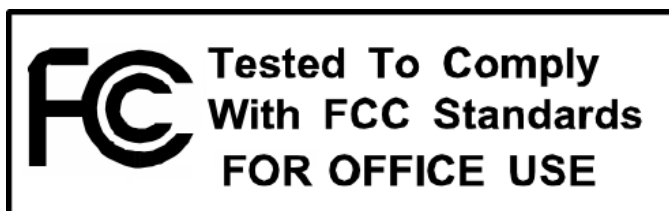

Sending in your registration card – or registering online at <http://www.echoaudio.com/register.html> - allows us to register key information so that we may handle problems faster and inform you of advance information on upgrades and other news. Thanks in advance for filling out your registration card and sending it to us. We hope you enjoy your Echo product.

Limited Warranty

Echo Digital Audio Corporation warrants this product, when purchased at an Authorized Echo Dealer in the United States of America, to be free of defects in materials and manufacturing workmanship for a period of one year from the date of original purchase. During the warranty period Echo shall, at its option, either repair or replace any product that proves to be defective upon inspection by Echo. Final determination of warranty coverage lies solely with Echo. Echo reserves the right to update any unit returned for repair, and reserves the right to change or improve the design of the product at any time without notice.

This is your sole warranty. Echo does not authorize any third party, including any dealer or sales representative, to assume any liability on behalf of Echo or to make any warranty for Echo.

Service and repairs of Echo products are to be performed only at the factory (see below) unless otherwise authorized in advance by the Echo Service Department. Unauthorized service, repair or modification will void this warranty.

To obtain factory service:

Contact Echo Digital Audio Corporation at (805) 684-4593, 9AM to 5PM Monday through Friday (Pacific Time). If necessary, you will be given a return authorization number. Products returned without an RA number will be refused. Echo may, at its option, require proof of the original date of purchase in the form of a dated copy of the original authorized dealer's invoice or sales receipt. Pack the product in its original shipping carton and attach a description of the problem along with your name and a phone number where Echo can contact you if necessary. Ship the product insured and freight prepaid to:

**Echo Digital Audio Corporation
6460 Via Real
Carpinteria, CA 93013**

DISCLAIMER AND LIMITATION OF WARRANTY

Echo makes no other warranties, express, implied, or otherwise, regarding Echo products, and specifically disclaims any warranty for merchantability or fitness for a particular purpose. The exclusion of implied warranties is not permitted in some states and the exclusions specified herein may not apply to you. This warranty provides you with specific legal rights. There may be other rights that you have which vary from state to state.

In no event will Echo be liable for any lost profits, or for any consequential, direct or indirect damages, however caused and on any theory of liability, arising from this warranty and sale.

©2000 by Echo Digital Audio Corporation
6460 Via Real
Carpinteria, CA 93013

Echo[®], Layla[®] 24, Mona[™], Gina[®] 24, Layla[®], Gina[®], Darla[®] 24 and Darla[®] are trademarks of Echo Digital Audio Corporation
ADAT[®] is a registered trademark of Alesis Corporation
Macintosh[®], Power Mac[®], iMac, G4[®], G3[®] and Power PC[®] are registered trademarks of Apple Computer, Inc.

Table of Contents

Introduction	6
What You Should Have Received in the Mona Box	6
System Requirements	6
Mona Installation	7
Checking your Macintosh	7
Install ASIO based Multitrack Recording Software	8
Installing the Mona Hardware	9
Connecting to Mona's Rack-mount Audio Interface	12
Running the Echo24 Card Installer	18
ASIO Driver Installation & Configuration	20
The Echo Console	21
Input Levels	22
Monitor Channels	22
Setting Clock Sources and Destinations	24
Synchronizing Multiple Devices	24
Digital Mode Switch	27
Show ADAT Controls	28
The Options Menu	29
S/PDIF Output Format	29
ASIO Based Software and the Echo Console	30
ASIO Control Panel	32
Contacting Customer Service	33
Appendix A: General Troubleshooting Guide	34
Appendix B: ASIO Audio Software FAQ	38
Appendix C: An Introduction to Digital Recording	40
Appendix D: Specifications	47
Index	49

Introduction

Thank you for choosing the Mona 24/96 Digital Studio. We think you'll find Mona to be an extremely flexible, high-performance tool for your computer-based hard disk recording system.

What You Should Have Received in the Mona Box

When you opened the Mona box, you should have found the following:

- A Mona PCI card wrapped in an anti-static cover
- A Mona rack-mount audio interface box
- A Mona interface cable
- A power cord
- A CD-ROM containing the Mona Macintosh Installer and demo versions of digital audio recording, editing, and processing software from a variety of manufacturers
- The Mona owner's manual
- Four adhesive backed rubber feet and four mounting screws with collars.

System Requirements

In order to use Mona you'll need the following:

- An Apple brand Macintosh computer with PCI architecture expansion slots (version 2.1 PCI), a 604 or higher processor (G3 or G4 highly recommended), and a minimum 128Mb RAM (more highly recommended) running OS 8.1, 8.5, 8.6, 9.0 or 9.04. We will not be able to supply technical support for any non-Apple brand Macintosh clone computers. Also, Mona may not work properly if you have a processor upgrade card installed.
- A fast, high-capacity IDE, SCSI or firewire hard disk drive
- A audio software program that supports ASIO.
- Peripheral audio equipment, such as a mixer, microphones, studio monitors, musical instruments, etc.

Mona Installation

Complete Mona installation consists of performing a system check, installing ASIO based multitrack recording software, installing the Mona PCI card, connecting the rack-mount audio interface to the card, installing the Mona Macintosh drivers into your system, and manually installing the ASIO driver to your multitrack audio recording/editing application(s).

Checking your Macintosh

- 1. Do you have enough memory?** With your mouse select **Apple – About This Computer**. Look at the amount of **Built-in Memory** you have. You will need at least 128Mb to use Mona properly with your ASIO based software. It is highly recommended that you have more.
- 2. Is your processor fast enough?** If you have a G3 or G4 then you can skip to step three. If you have an older Macintosh, select **Apple System Profiler** from the **Apple** menu. Under the **System Profile** tab, look at the section entitled **Hardware overview** and see what kind of processor you have. If it's a PowerPC 604 or higher, then you can use Mona.
- 3. Do you have an open PCI slot?** Make sure that you have an open PCI slot in your Mac. If you don't know offhand, you will have to open up the Mac and look. Make sure you shut down the Mac and unplug the power cable before you open it. If you see an open PCI slot, then you're OK.

Please Note: Mona may not work properly if you have a processor upgrade card installed.

If your system checks out OK, it's time to move on to the next phase of installation.

Install ASIO-based Multitrack Recording Software

If you haven't already, we recommend that you install your ASIO based software now. Mona currently does not support Sound Manager. It only works with audio software that supports ASIO. For a list of currently supported ASIO-based software please see **Appendix B: ASIO Audio Software FAQ** in this manual. We frequently update our drivers, so please check our website at **www.echoaudio.com** for new drivers and an updated software compatibility list.

Installing the Mona Hardware

Once you have checked your system requirements, verified that there are no problems with your system, and installed your ASIO-based software, it is time to install Mona into your computer. Please refer to the section in your Mac manual for installing a PCI card.

IMPORTANT - Unplug your computer and detach all peripherals before proceeding with the following steps.

- 1. Remove your computer's cover.** This operation differs from computer to computer. Refer to your computer's manual for a further explanation of this step if necessary.
- 2. Select the slot into which you will install the Mona card.** You may use any of the available PCI slots in your computer for Mona. Remove the bracket covering the expansion slot where you would like to install Mona. If there was a screw for the bracket, put it in a safe place, as you will need it later to complete the installation.
- 3. Insure that you have fully discharged all static electricity from your body before handling the Mona card.** This can be done through the use of a grounding strap or, more simply, by touching your bare hand to the metal casing of the computer's power supply. (For this latter method to work, the computer must be plugged in, though not turned on.) After you've discharged your static, unplug the computer before proceeding to the next step.
- 4. Insert card into slot.** Remove the Mona card from its protective anti-static bag. Handle the card carefully by its edges and insert it into the selected expansion slot. Insure that the card's edge connector (the protruding edge with the gold leads) is seated firmly into the slot. Centering the card over the slot and using a gentle rocking motion while pushing downward into the slot generally works well. Be careful not to force the card into the slot, or bend or twist it while it is being inserted, as this could result in the card being damaged.
- 5. Secure card to computer.** If there was one, use the screw removed earlier from the protective back-plate to attach the metal bracket on the

Mona card to the computer's rear panel. *On some older Macs, the locking mechanisms used to hold down the PCI cards cause difficulties properly seating the cards.* We recommend checking the card and making sure it is well seated and liable to stay that way. If the card is loose or being pushed around by the locking mechanism, we recommend loosening the hex screws that hold the back-plate of the card to the Mac. The back-plate is the thin piece of metal connected to the Mona card that sits against the case of your computer. Another option, if that piece needs a little more play, is to gently bend it back. Some users have broken the plastic that comes with their Mac to solve this problem. However, due to Mac warranty issues, we are not able to recommend this approach.

6. **Attach Esync cable.** OPTIONAL: *If you don't have a Darla24 or Gina24, you can skip this step.* If you also have a Darla24 or Gina24, this would be a good time to attach an Esync cable to the Mona PCI card. Esync is a proprietary form of super clock that allows you to sync together multiple 24-bit Echo products. Esync cables come with Darla24 and Gina24, and can be used to daisy chain several 24-bit Echo cards together. Simply attach the Esync cable to the two prong "Esync Out" connector on the Mona PCI card, and attach the other end to the "Esync In" connector on your Darla24 or Gina24 PCI card.
7. **Replace the computer's cover and secure it.** Please refer to your Macintosh manual for instructions. Reattach its power supply cord and reconnect any peripherals that you may have removed prior to beginning the Mona installation.
8. **Locate the Mona rack-mount interface and the 9-pin interface cable.** Securely mount the interface into your equipment rack. If you will not be mounting the box in a rack, remove the backing from the four rubber feet and place one in each bottom corner of the interface unit. Then be sure to locate the rack-mount box in a secure location.

Plug one end of the cable into the 9-pin connector on the Mona card that now protrudes through the back panel of your computer, and secure the cable using the built-in screws located on both sides of the connector. Attach the other end of the cable to the rear of the interface and fasten the cable securely with the screws. Plug the power cord firmly into the interface and a power socket, but do not turn on the interface at this time.

Caution: Never connect the rack-mount interface to the computer while either the interface or your computer is turned on.

9. You can now attach external audio devices to the interface box. Mona can accommodate four analog input signals and can generate six independent analog output signals. In addition, Mona provides stereo S/PDIF digital input and output via coaxial RCA or optical connectors, and eight channels of ADAT optical I/O. The analog and digital inputs and outputs on Mona are simultaneously active, except that the digital mode must be set to either S/PDIF or ADAT. *The S/PDIF and ADAT I/O cannot be used simultaneously.* This allows you to record up to 12 channels of audio (four analog and eight digital) while playing back 14 channels (six analog and eight digital) in ADAT mode, or record up to 6 channels (four analog and two digital) while playing back 8 channels (six analog and two digital) in S/PDIF mode. Additional information on attaching external devices to Mona may be found in the **Connecting to Mona's Rack-mount Audio Interface** section.

(NOTE: When connecting devices to the S/PDIF jacks on Mona, do not use standard analog RCA audio cables. For reliable S/PDIF operation, 75ohm coaxial video cables are recommended).

Connecting to Mona's Rack-mount Audio Interface

The front and back panels of Mona's rack-mount audio interface contain a wide variety of connections that allow great flexibility in the operation of Mona. To achieve the optimal performance with Mona, it is critical that the appropriate cabling and connectors are used.

Analog Inputs and Outputs

Mona has four analog inputs on the front panel, and six analog outputs on the back panel. The universal input connections can accept unbalanced or balanced signals via 1/4" or XLR connectors. Since Mona has built-in preamps, you can just plug your microphone or guitar cable right into any of Mona's analog inputs. No external preamp or mixer is needed!!

Mona's "universal" inputs can be thought of as three inputs in one: a microphone input, a line input, and a guitar input.

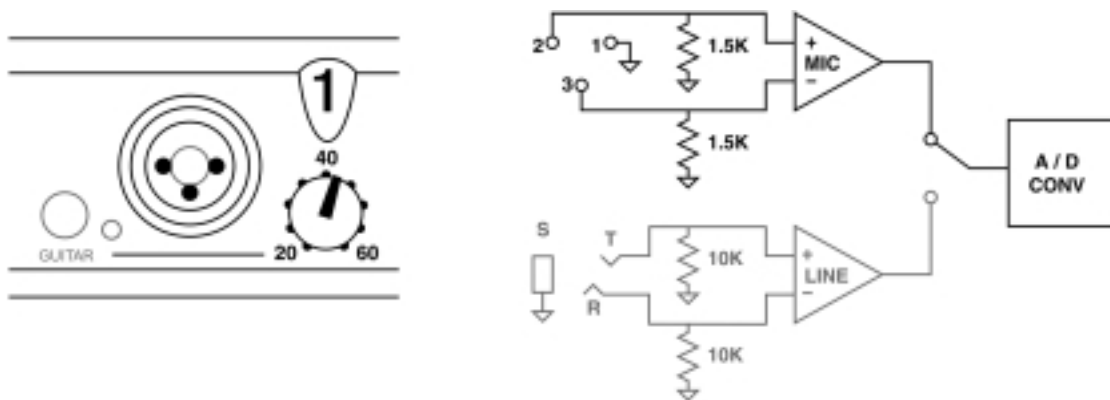

**Mona's Mic Preamp Input (XLR, Impedance: 1.5K,
Trim: 20 - 60 dB)**

To use a microphone with Mona, plug the microphone's XLR cable into any of the analog inputs. Whenever an XLR cable is connected to an input, the microphone preamp is enabled and the gain range of the trim knob is set to range from +20 to +60dB. The input impedance of the mic preamps is 1.5K.

Mona provides 48 volts of phantom power for microphones that require it. To enable phantom power press the button labeled **+48V** (the LED next to it will light up) and phantom power will be provided to all microphone inputs. Note: Phantom power will not be applied to any line level equipment or guitars plugged in using 1/4" connectors.

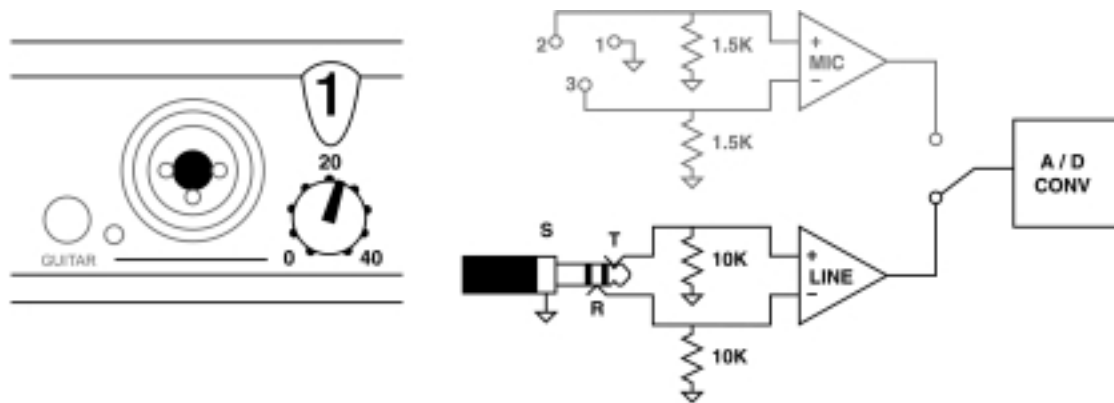

Mona's Line Input (1/4" TRS, Impedance: 10K, Trim: 0 - 40 dB)

When a 1/4" connector is plugged into Mona's universal input jack, the microphone preamp is disconnected and a line input amplifier is inserted in its place. If the **GUITAR** switch is out, the line input provides a balanced connection (for TRS plugs) and the trim knob has a range of 0 to 40dB. The input impedance for line level signals is 10K. Full-scale input is 22dBu with the trim set to zero.

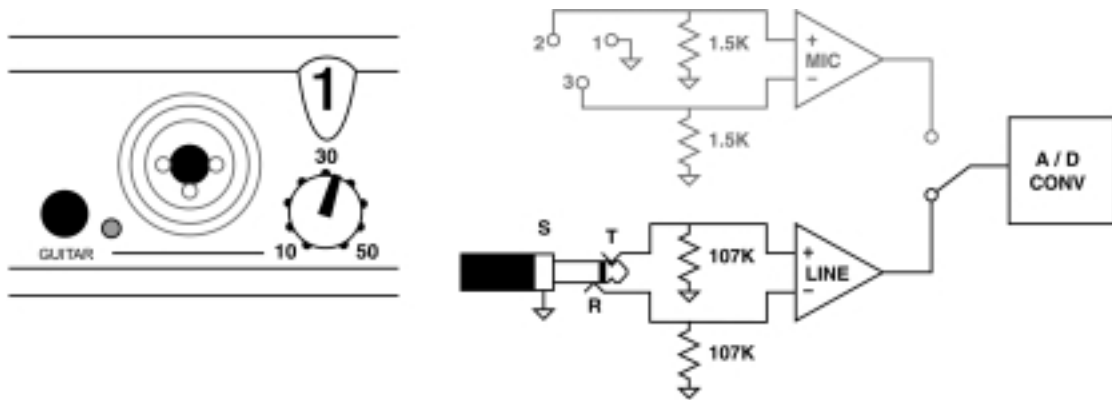

**Mona's Guitar Input (1/4" Plug, Impedance: 100K,
Trim: 10 - 50 dB)**

An input impedance of 10K is too low to record non-active guitar pickups so each input also has its own **GUITAR** switch. When the **GUITAR** switch is pushed in (green indicator lit), the input impedance is increased to 107K and the trim knob has a range of 10 to 50dB. The indicator will only light up if there is a 1/4" connector plugged into the jack. This mode will still provide a balanced input when a TRS connector is inserted.

If you want to adjust the level of any input, just turn the knob for that input and watch the corresponding level meter on Mona's front panel. The red bar at the top will light anytime the input signal is greater than -3dB (or within 3dB of clipping). The three yellow bars each represent a range of 3dB and the green bars each represent a range of 6dB.

It is a good idea to adjust the input trim (knob) so that your loudest recorded signal lights up some of the yellow bars but not the red. If the signal level ever exceeds 0dB the signal will be "clipped" and you will hear a "pop" or "tick" in the recording. This is a *very bad thing*, and clipping should be avoided at all costs! Mona has enough headroom so that you can be conservative in this area and there is no need to push the input levels right up to the edge of clipping.

Mona's front panel also has a 1/4" headphone output jack with a corresponding volume knob which monitors analog outputs 1 and 2.

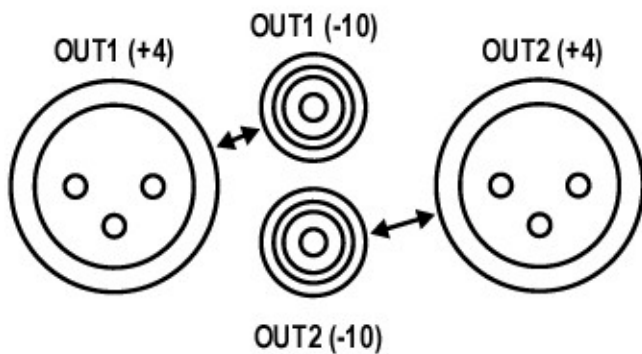

Each of Mona's six outputs has one RCA and one XLR connector for your convenience. The RCA jack outputs a -10dBV (unbalanced) signal, while the XLR jack outputs a $+4\text{dBu}$ (balanced) signal. Both connectors are active at all times. So the output signal will always go out of both jacks.

The Computer Connector

Next to the analog inputs and outputs is a connector labeled **COMPUTER**. This connector is known as a DB-9, and is similar to the serial port on a PC. It is the point at which the audio interface connects to the Mona PCI card inside your computer.

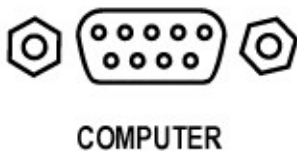

A cable was supplied with your Mona for this purpose. This custom made cable is manufactured to certain specifications and, if necessary, should only be replaced by a special Mona cable available only from Echo.

ADAT / S/PDIF Optical I/O

Next to the **COMPUTER** connector is a pair of connectors labeled **OPTICAL, IN** and **OUT**. These connectors are used to transmit digital data among digital audio devices via an optical signal.

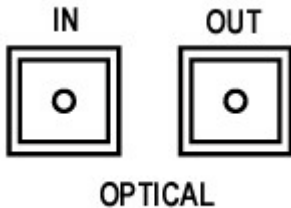

You can use this port for ADAT (8 channels) or for optical S/PDIF (stereo) I/O. **NOTE:** Mona is only capable of transmitting or receiving one type of digital signal at a time. You must choose either ADAT optical or S/PDIF (optical or RCA); you cannot use both simultaneously. The **Digital Mode Switch** can be found in the Mona Echo Console. For more information, see the appropriate section in this manual under the heading “**The Echo Console.**”

S/PDIF

Next to the **ADAT** connectors is a pair of connectors labeled **S/PDIF, IN** and **OUT**. These S/PDIF connectors are used to transmit digital data among digital audio devices via an electrical signal. S/PDIF data can use the full 24-bit sample width used internally on Mona.

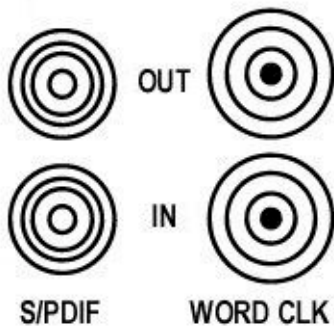

When connecting devices to the S/PDIF jacks on Mona, the use of standard analog RCA audio cables is not recommended. For reliable S/PDIF operation, 75-ohm coaxial (RG59) video cables are recommended.

Word Clock

Next to the S/PDIF ports are the **Word Clock** connectors. These connectors allow you to synchronize one Mona to another Mona, Layla, Layla24, or to other digital audio devices.

The word clock I/O uses a BNC connector. As with the S/PDIF I/O, a shielded 75-ohm (RG-59) coaxial video cable should be used. BNC connectors are widely used in the electronics industry for both video and computer networking. However computer networks use 50-ohm (RG-58) coaxial cables and not the 75-ohm (RG-59) cable used by video. For reliable word clock operation, use only video grade cables with Mona.

Running the Echo24 Card Installer

Now that you have completed the hardware installation, you need to run the installer for Mona to interact properly with the Mac OS and your ASIO-based recording software.

1. **Power up.** Turn on the power to the Mona box and then power up your Macintosh.
2. **Start the Installer.** Insert the Mona Installation CD into your CD-ROM drive. Double click the icon called **Install Echo24 Card**. Click the **Continue** button. Read the **Readme and Installation** guide that appears so that you will be aware of any important updates. If you want to read it later, you are given the option to **Print...** or **Save As...** When you are done reading just press the **Continue** button.



3. **Install software.** Now you will be able to choose where the Echo24 Console software is installed. The default setting will place the Echo folder in your main hard drive. When you are ready, click the **Install** button. The installer will now create an Echo folder where you told it to and place the Echo24 Console and the ASIO Echo24 driver inside it.



4. **Installation completed.** You will now see a message telling you that the installation was successful. Go ahead and click the **Quit** button. If you do not see this message, then please turn to **Appendix A: General Troubleshooting Guide** in the back of this manual for help.



ASIO Driver Installation & Configuration

Now that you've run the Echo24 Card Installer program, you will need to manually install the **ASIO Echo24** driver.

1. **Find it.** Find the **ASIO Echo24** file in the newly created **Echo** folder.
2. **Copy it.** Create a copy of this file. You will need one copy for every ASIO based software program you have installed. You can copy it by dragging it to the desktop (or another folder) while holding down the **option** key.
3. **Move it.** Put a copy of the **ASIO Echo24** file into the **ASIO Drivers** folder of your ASIO based software program. You will need to do this separately for each ASIO based software program you have installed.
4. **Configure it.** You will now need to select and configure the **ASIO Echo24** driver from within your ASIO based software program. Please refer to the manual for your ASIO based software on how to do this.

This completes the installation of the Mona hardware and software.

The Echo Console

Included with your Mona is a “virtual control surface” application called the Echo Console. The Console allows you to control the audio I/O and clocking functions of Mona, and it brings these controls to a single easy-to-use location. From the Console you can control the input monitoring, select synchronization clocks, and select the digital mode.

The Echo Console software can be found in the **Echo** folder that was created during installation. Double-clicking on the **Echo Console** icon will activate the console program. It should look like this:

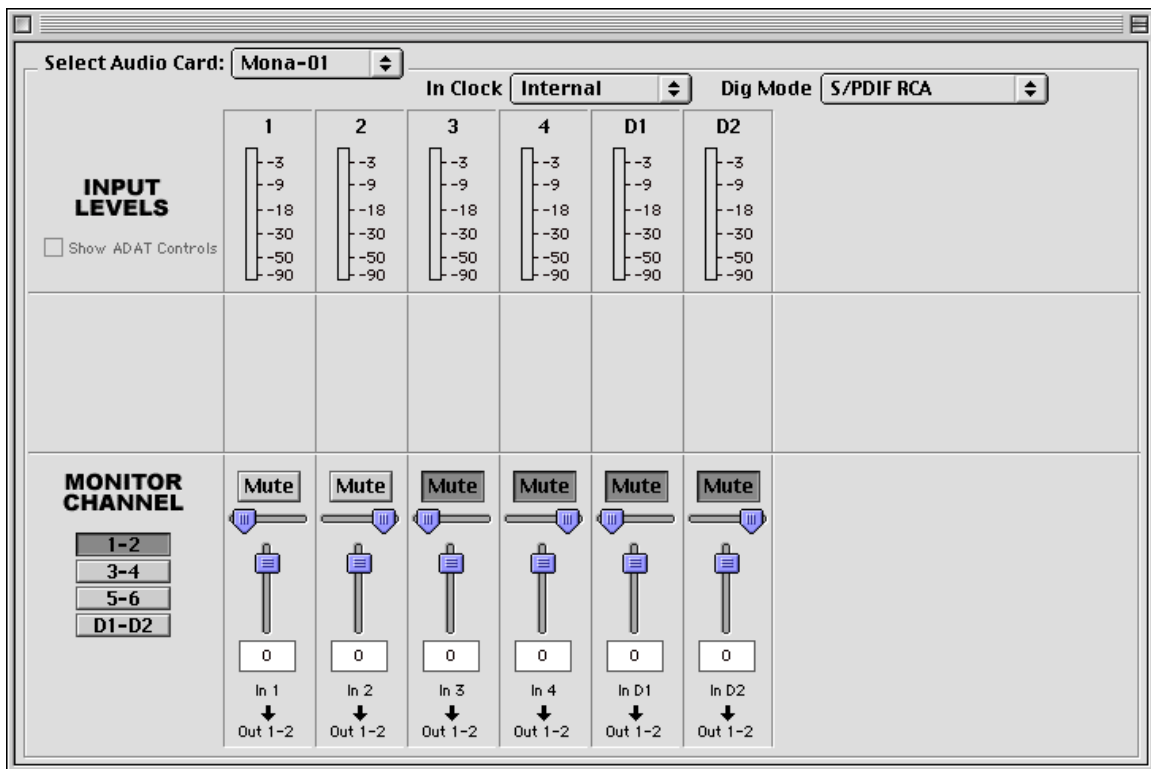

The Console functions are grouped into three areas: clock and digital mode selection (at the very top), input levels (occupying the top half), and monitor channels (at the very bottom).

Input Levels

The **Input Levels** are located in the upper portion of the Console surface. Here you will find level meters for all of Mona's analog and digital inputs. Since Mona has analog input trims on its rack-mount interface box, there are no other controls in this area of the Console.

Monitor Channels

Below the **Input Levels** are the **Monitor Channel** controls. The **Monitor Channel** controls allow you to monitor the input signals via any of the available outputs on your Mona. Each input channel has a corresponding monitor channel directly below it on the Console. At the top of each monitor channel is a button that allows you to selectively **Mute** each channel. Directly below that is a pan control that will pan between the two channels in the designated stereo output pair. In the middle you will find a fader that determines how much of the input signal is sent to the designated stereo output pair. Below the fader is a display that shows the currently selected level of attenuation. In addition to using the fader, you can change this level by clicking in the display, typing, and then pressing **return** on your keyboard. There is also a group of numbered buttons on the bottom left. These buttons allow you to select which set of monitor controls will be displayed.

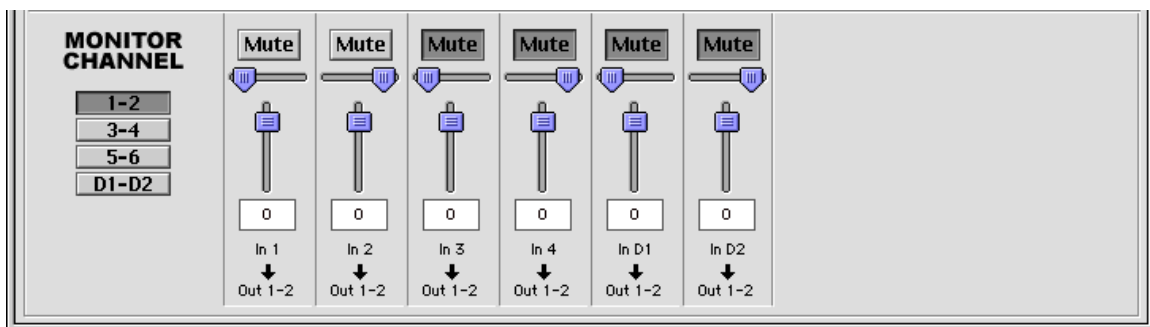

The Echo Console will keep track of the settings for all sets of monitor controls, but is only able to display the settings for one output pair at a time. For example, when the **1-2** button is selected you will see the controls for monitoring all inputs through output pair 1-2. Selecting the **3-4** button will display just the controls for monitoring through output pair 3-4, etc. Take note that these controls are only for the routing of audio signals from Mona's inputs to its outputs. The Console does not control output signals that are generated by your computer (such as when playing audio files). Those output signals are controlled by whatever audio software you are using.

When setting a monitor level, you must first select the input that will be monitored, and then select the output for which you will set the monitor level. Selection of the input is really just a matter of using the correct monitor control box. A monitor setting will always affect the input channel that is directly above it. To set the monitor for input 1, for example, simply go to the monitor control directly below input 1 and click on one of the buttons found on the left side to select the appropriate output pair.

Let's say you want to set the level at which input 1 is monitored for each of the three stereo analog output pairs on Mona. You would first find the monitor control that corresponds to input 1 (the control on the far left, directly below the input level for channel 1). Clicking on the button labeled "**1-2**" causes the control box to display the currently selected levels at which input 1 is being monitored at output pair 1-2. Clicking on the button labeled "**3-4**" would cause the control box to display the currently selected level at which input 1 is being monitored at output pair 3-4. You can move through the remaining buttons, setting the level at which input 1 is monitored at each of the three analog output pairs, as well as the S/PDIF "**D1-D2**" and ADAT "**ADAT 1-2**" outputs. The Console program remembers any settings that you make, and all input monitor settings for all output pairs are maintained independently.

Note: You cannot monitor the S/PDIF inputs through the ADAT outputs and vice versa. This is because you can only use one digital mode (S/PDIF or ADAT) at any given time. For more information, please see the section "**Digital Mode Switch**" later in this manual.

Remember that all of the monitor controls remain in effect even when they're not displayed. The degree of attenuation (or muting) of each level is set by the monitor controls. The Console program constantly maintains a level setting for each of the monitor paths it controls. Clicking on an output pair selection button simply selects the settings that are displayed.

Setting Clock Sources and Destinations

At the top of the Console there is a drop down menu labeled **In Clock** that allows you to select the synchronization clocks that are used by Mona. The console program will detect which input clocking options are available, and automatically disable those that are unavailable. Depending on what external devices you have connected to Mona, you may have as many as three out of four options available.

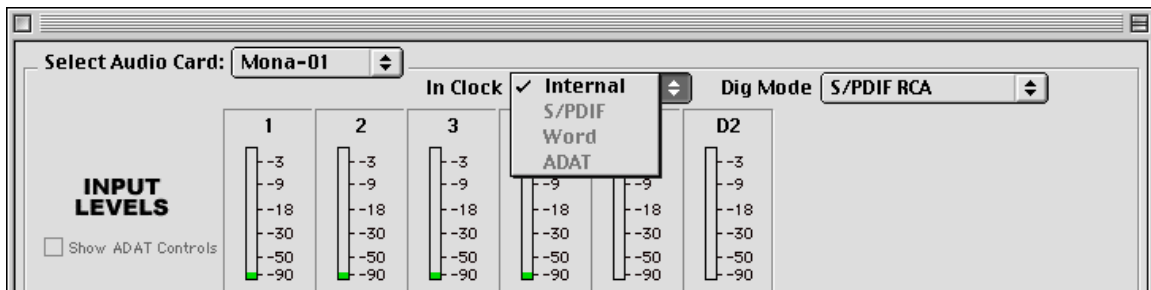

If you are unsure which clock synchronization selections are appropriate for your installation, be sure to read the next section, which deals with the types of clocks that Mona supports.

Synchronizing Multiple Devices

Mona is designed to work alongside other audio equipment. If you are planning on using Mona with other audio equipment, please note the following:

The Mona Macintosh drivers included in this package support multiple Monas within the same system. In addition, your new Mona will operate alongside Layla24, Layla, Gina24, Gina, Darla and Darla24. Mona can also peacefully coexist with audio equipment from other manufacturers, but be

aware that operating *alongside* another product is not the same as operating *with* it. In order for accurate synchronization to occur, the other audio product(s) in your system must support a synchronization mode that is compatible with Mona. Without such synchronization, the individual pieces of equipment will act independently of each other. This scenario may be fine for some musical applications; however, it is not appropriate for situations where sample-accurate synchronization is required.

For this reason, Mona supports many synchronization modes. Mona can slave to Word clock, S/PDIF, and ADAT. In addition, Mona can also generate these synchronization signals and Esync, as well as perform translation of one clock to another, such as transmitting Word while reading ADAT.

Let's take a brief look at the various synchronization types.

Word Clock – This is a synchronization signal that connects to the BNC connector labeled **Word Clock** on Mona's back panel. This synchronization clock runs at the selected sample rate. Think of it as a kind of electronic metronome, which clicks back and forth at the digital sample rate. It is one of the most widely used forms of synchronization in digital audio. Mona is always generating Word Clock on its Word Clock output BNC connector. Although it can generate Word clock at any sample rate it is set to, Mona can only sync to Word clock if the master device is set to a sample rate between 30kHz and 100kHz. Otherwise you will get noise and/or loss of sync.

S/PDIF – The Sony/Phillips Digital Interchange Format is a serial bit-stream that has a clock signal embedded in the data stream. When recording from an S/PDIF source, whether via optical cables or RCA cables, Mona will utilize the synchronization clock that is embedded in the S/PDIF while it decodes the bitstream. Mona can only sync to S/PDIF clock if the master device is set to a sample rate between 30kHz and 50kHz. Otherwise you will get noise and/or loss of sync.

Note: When recording from a S/PDIF port, you must select **S/PDIF** as the input clock. For greater flexibility, this is not done automatically. If you find that your S/PDIF recordings contain pops or skips, be sure that you have selected **S/PDIF** as your input clock.

ADAT – The Alesis ADAT optical interface can send and receive up to 8 simultaneous channels of digital audio data over fiber optic cables. Unlike wire cables, fiber optic cables do not add noise or interference. Mona can send out (or “master”) ADAT clock as well as slave to it. If you want Mona to slave to an ADAT clock, just set Mona’s input clock to the **ADAT** setting. Mona can only sync to ADAT clock if the master device is set to a sample rate between 40kHz and 50kHz. Otherwise you will get noise and/or loss of sync.

Note: To preserve the high audio quality of Mona’s converters it is best to use Mona’s **Internal** input clock setting instead of synchronizing to an external ADAT clock, which may add unwanted jitter to the signal.

Esync – Esync is a proprietary form of super clock that is used to synchronize two or more Echo 24-bit products like Mona, Layla24, Gina24, and Darla24. While Gina24 and Darla24 have both input and output connectors on their PCI cards, Mona and Layla24 only have the Esync output connectors. Mona is always outputting Esync clock. For more information please read step 6 in the section entitled “**Installing the Mona Hardware**” in this manual.

Now let’s take a look at some possible configurations and how you might set them up from a synchronization standpoint.

Let’s start simple. Suppose that Mona is the only audio device used in your system. Since you have no other devices to synchronize with, simply select **Internal** for Mona’s input clock. Mona will then use its own clock to control its operation.

Now a little more complicated set-up: You have two Monas connected. Simply set Mona #1 to **Internal** for its input clock. Now connect the first Mona to the second one via a BNC cable running from Word Clock Out on Mona #1 to Word Clock In on Mona #2. Now select **Word** for Mona #2’s input sync. The second Mona will slave to the first one and your Monas will now operate in unison.

No matter how many devices you are synchronizing, the concept is essentially the same. You are merely “daisy-chaining” devices together

using compatible clocks. One device will operate as the source of the master clock, with each successive device using that clock to sync.

Digital Mode Switch

To the right of the Input clocks is a dropdown menu labeled “**Dig Mode.**” This menu allows you to select which digital inputs/outputs Mona will use at any given time. The options are **S/PDIF RCA**, **S/PDIF optical**, and **ADAT optical**. Mona can only use one digital mode at a time.

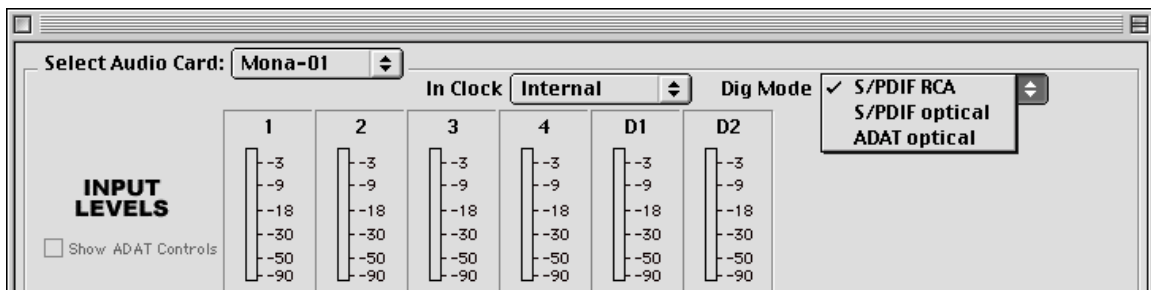

When one of the two S/PDIF modes is selected, the “**Show ADAT Controls**” checkbox will be grayed out. You can only access the ADAT controls when the ADAT mode is currently selected.

Note: Sample rates above 48kHz will not be available while ADAT mode is selected. This is because the ADAT optical standard does not support sample rates higher than 48kHz.

Show ADAT Controls

While you are in the **ADAT optical** digital mode, you can view the Console ADAT controls at any time by checking the “**Show ADAT Controls**” checkbox. As seen below, these controls are the same as the monitoring controls. If you want to go back to the analog controls, just uncheck the “**Show ADAT Controls**” checkbox. You cannot monitor the S/PDIF inputs through the ADAT outputs or vice versa.

Note: If at any time you switch the digital mode to one of the S/PDIF options, the ADAT controls will become unavailable and the Console will return to displaying the analog and S/PDIF controls.

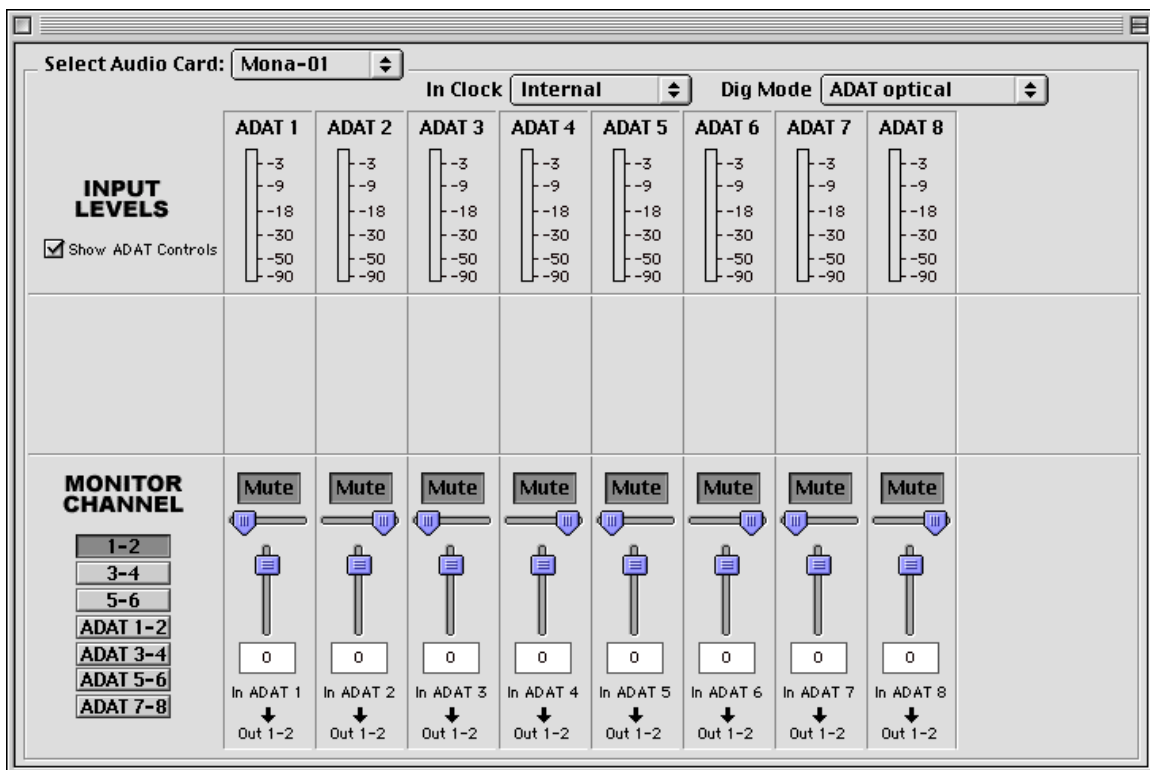

The Options Menu

The first option **General...**, is grayed out because it is not currently supported. It will be used in future driver releases for such things as resetting the Console to its default settings.

The second and third options are **Set Input +4/-10...** and **Set Output +4/-10...**. These options are also grayed out since they are not used for Mona. Instead of having these software options, Mona has input trim controls and dedicated +4dBu and -10dBV outputs on its rack-mount audio interface box.

The fourth option is **MTC Settings...**. This option is also grayed out as it is only used for Layla24.

S/PDIF Output Format

The fifth and sixth options are **S/PDIF Pro** and **S/PDIF Consumer**. Mona can transmit digital information in either of two formats, “professional” or “consumer.” The primary difference between the two is in the implementation of the SCMS copy protection bit, which, in the **Consumer** format, prevents the user from making digital copies of a digital copy.

Mona’s S/PDIF output defaults to the **Professional** format. If you are recording from Mona into a consumer DAT deck, CD recorder, or Mini Disc recorder, the device may not be able to recognize the signal until you switch Mona’s output to **Consumer**.

We have provided a software switch in the Mona driver that allows you to select which format Mona transmits. In the **Options** menu, you’ll see a check next to **S/PDIF Pro** or **S/PDIF Consumer**. The format that is checked is the current one. Select the appropriate format for your DAT, CD recorder, or Mini Disc recorder (if you don’t know which one to use and are having difficulties, simply try the one that is not currently checked).

Important note: Mona never transmits the SCMS bit; regardless of which format is selected.

ASIO Based Software and the Echo Console

Depending on what software you use, you will have different options for monitoring your audio inputs. The more common type is software monitoring. With software monitoring, your audio application handles mixing inputs to outputs internally (i.e., on the PowerPC processor). Typically, this adds latency, meaning that the audio you hear on the outputs is delayed from the inputs.

Your Mona hardware has an on-board DSP chip which can also handle mixing inputs to outputs. Since this is done on the DSP, it lightens the load on the PowerPC chip and has virtually no latency. This is referred to as hardware monitoring. Hardware monitors can be controlled from the Echo Console.

With the advent of ASIO 2.0, software programs can control the hardware monitors directly. This is called **ASIO Direct Monitoring**. The ASIO driver for Mona supports Direct Monitoring. However, not all ASIO based programs support Direct Monitoring. Cubase VST version 4.1 (or higher) is one program that does support **Direct Monitoring**.

Things can get a little tricky, however, if you try to control your monitors simultaneously in the console and in your audio software. Your best bet is to pick one or the other and stick with it. The monitor controls in the Echo Console and the monitor controls within your audio software can't communicate with each other, so your monitors may behave unpredictably if you switch back and forth during a session.

Here are a few different scenarios for monitoring your inputs:

I want to just listen to my inputs without using any audio software

Run the Echo Console and control your monitors from there.

I want to use Direct Monitoring

Use Direct Monitoring in your software, but don't use the Echo Console for monitoring. Only use the Echo Console for clock synchronization.

I want to use software monitoring

Run the Echo Console and mute all the monitors. This will disable hardware monitoring. Using hardware and software monitoring simultaneously won't hurt anything, but you'll get a noticeable delay effect in your outputs (kind of like a slapback echo) since the hardware and software monitors have different latencies.

The best method, therefore, is to mute the monitors in the console and to control your software monitoring from within your audio application.

No matter which type of monitoring you use, if you choose to use either the software or hardware monitoring within your ASIO program, this will determine how you should use the Echo Console. If you use your ASIO program for monitoring, then you should only use the Echo Console for setting the **Digital Mode** and the **Input Clock**. If you use both your ASIO program and the Echo Console for monitoring, the Echo24 ASIO driver will get confused (this is bad).

NOTE: You cannot change the digital mode while an ASIO program is running – you must shut down the program, make the change in the Echo Console, and then restart the ASIO program. S/PDIF and ADAT inputs and outputs are not simultaneously active. The **Digital Mode Switch** in the Echo Console determines which digital mode is currently active.

ASIO Control Panel

In all ASIO programs you can access a special window that lets you control certain hardware settings for your Echo24 card. Each ASIO program has a different name for it (ASIO Device Control Panel, Hardware Settings, Driver Setup, etc...) and a different way of accessing it.

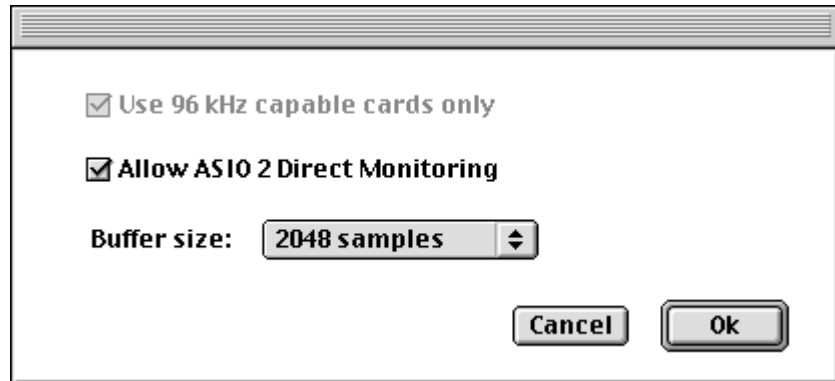

There are two controls in this window that you can use. The **Allow ASIO 2 Direct Monitoring** checkbox does exactly what it say it does. If you don't want the option of using Direct Monitoring, then make sure this box is unchecked.

The other control is labeled **Buffer size**, and allows you to change the buffer size so you can get lower latency using Mona. Generally, a smaller buffer size will result in a lower latency. However, the speed of your computer processor may also affect this. If you have a really slow machine, then using a very small buffer size may cause you to have breakups in your audio. If this happens, then just make the buffer size larger until you no longer hear the breakups.

Contacting Customer Service

If you experience any trouble with your Mona system please go to the support area of our website at www.echoaudio.com and check out the tutorials & troubleshooting FAQ's we have there. If you can't find a solution to your problem there, please fill out the provided technical support email form. This form will be sent to our technical support staff and they will respond to you quickly. **Please fill out the form completely.** The best way to get the help that you need is by giving us plenty of detailed information about your computer system, your audio software and the problem you are having.

We do ask you to please read through this manual and the support area of our website before contacting us. You may also find an answer to your problem using the Appendices in the Mona owner's manual.

Thank you for buying Mona!

Appendix A: General Troubleshooting Guide

Problem: You can't get Sound Manager to recognize your Mona.

Solution: The current driver does not support Sound Manager. It only supports ASIO based programs. We will be adding Sound Manager support to our driver at a future date.

Problem: You upgraded your computer with a processor upgrade card and now Mona doesn't work.

Solution: Mona is not compatible with processor upgrade cards. It only supports genuine Apple processors without upgrades. You will have to uninstall the processor upgrade card to get Mona to work again with your computer.

Problem: You can't get Mona to work under OS X.

Solution: The current driver does not support OS X. It only supports OS 8.1 through 9.04.

Problem: You can't get Mona to work with your iMac or G4 Cube.

Solution: The iMac and G4 Cube are not equipped with PCI expansion slots. PCI expansion slots are required for you to install the Mona PCI card.

Problem: You are unable to get your DAT recorder to recognize Mona's S/PDIF output.

Solution: Digital information is transmitted in either of two modes, "professional" or "consumer." The professional mode is usually implemented in devices that are likely to be used in professional recording environments, whereas the consumer mode is commonly implemented on equipment designed for home use in the consumer market. The primary

difference between the two modes is in the implementation of the SCMS copy protection bit, which, in the consumer format, prevents the user from making digital copies of a digital copy. In most professional equipment, this copy protection bit can be turned off or on according to the user's needs. In consumer products, the SCMS bit is always enabled.

Unfortunately there is no way for the transmitting device to automatically detect which format the receiving device is able to accept. If you have a DAT deck that is not able to read the S/PDIF output from Mona, chances are Mona is transmitting in the mode that the deck is not equipped to handle.

We have provided a software switch in the Mona driver that allows you to select which mode Mona transmits. To access this switch go to the Mona **Echo Console**. In the **Options** menu select either **S/PDIF Pro** or **S/PDIF Consumer**. Select the appropriate format for your DAT (if you don't know which one to use, simply select the one that is not currently checked). Now try recording to your DAT again.

Important note: Mona never transmits the SCMS bit; regardless of which mode is selected.

Problem: When you play an audio file, it plays at an altered pitch.

Solution: When Mona is set to sync with an external device, it will play back at the rate generated by that device. If the sound you are playing was sampled at 11kHz (for example), but you are synchronized with a device running at 44.1kHz, the sound will play back at this faster rate. You have four choices - ignore the altered pitch, switch to Mona's internal clock, change the sample rate of the external device, or use a different device for the sound playback.

Problem: Mona doesn't seem to recognize the synchronization clock to which it is connected.

Solution: Although it may seem obvious, the first thing to check is that there is a physical connection between the device generating the clock and

Mona's rack mount interface. Just because multiple devices are connected to the same computer doesn't mean they are synchronized. Next, be sure that you have selected the desired input clock source in the Mona **Echo Console**.

Problem: Recordings made using the S/PDIF port contain occasional pops or skips.

Solution: When recording with the S/PDIF port, you must manually select the S/PDIF clock as the input clock. This can be done using the Mona **Echo Console**.

Problem: You keep hearing a high-pitched squealing sound or your S/PDIF or ADAT signal has gone crazy.

Solution: Reset the sample rate of Mona. You may have set the sample rate to 11kHz or 22kHz. Because neither S/PDIF nor ADAT support these rates, you will have problems syncing until you reset Mona's sample rate to one within spec (like 44.1 or 48kHz). You can do this through your ASIO program's controls or by playing an audio file of the appropriate sample rate through Mona's outputs. Then you will be able to sync properly.

Problem: I can't get Mona to record at 96kHz.

Solution: Set the Digital Mode to one of the S/PDIF options. You can change this setting from the Echo Console. When the Digital Mode is set to ADAT you are limited to the sample rates that are within the ADAT spec (such as 44.1 and 48kHz). Please note that you can only record above 48kHz through the analog I/O. We will add support for recording through S/PDIF at 88.2 and 96kHz in a future driver release.

Problem: The sound cuts in and out, or the left or right channel doesn't work.

Solution: You may have a bad audio cable. Try using a different cable in the problem channel.

Problem: There is no sound unless I pull the audio plug out a little.

Solution: Not all ¼” plugs are made to the exact same dimensions. Try a plug/cable from a different manufacturer.

Appendix B: ASIO Audio Software FAQ

ASIO Software Compatibility List – 11/06/2000

Cubase 4.0 (or higher)
Digital Performer 2.61 (or higher)
Metro 5.0 (or higher)
Peak 2.1 (or higher)

We are currently working on ASIO driver compatibility with Logic and other ASIO based programs for future driver releases.

Echo24 ASIO Driver and ASIO 2.0

Q: Can I use all Echo cards together at the same time in my ASIO program?

No. There are two different Echo ASIO drivers. One is for the Echogals cards (Layla, Gina, Darla & Darla24). The other is for the new Echo24 cards (Layla24, Gina24 & Mona). However, you can use multiple Echo24 cards together **OR** multiple Echogals cards, just not a combination from both groups.

Q: Can I use S/PDIF and ADAT simultaneously in my ASIO program?

No. The Echo24 cards (Layla24, Gina24 & Mona) can only use one digital mode at any given time (S/PDIF or ADAT). You will need to choose which one you want to use before you start your ASIO program. If you change digital modes while the ASIO program is running, it will confuse the program and you will need to close it and restart.

Q: What does ASIO 2.0 support do for me?

For our purposes, ASIO 2.0 adds ASIO Direct Monitoring. ASIO Direct Monitoring lets you control the monitoring features of your Echo card (low latency hardware monitoring) from within your ASIO program. Cubase VST version 4.1 is the first program to support Direct Monitoring, but other ASIO programs will probably support this feature in the future.

Appendix C: An Introduction to Digital Recording

Converting Sound into Numbers

In a digital recording system, sound is represented as a series of numbers, with each number representing the voltage, or amplitude, of a sound wave at a particular moment in time. The numbers are generated by an *analog-to-digital converter*, or ADC, which converts the signal from an analog audio source (such as a guitar or a microphone) connected to its input into numbers. The ADC reads the input signal several thousand times a second, and outputs a number based on the input that is read. This number is called a *sample*. The number of samples taken per second is called the *sample rate*.

On playback, the process happens in reverse: The series of numbers is played back through a *digital-to-analog converter*, or DAC, which converts the numbers back into an analog signal. This signal can then be sent to an amplifier and speakers for listening.

In computers, *binary numbers* are used to store the values that make up the samples. Only two characters, 1 and 0, are used. The value of a character depends on its place in the number, just as in the familiar decimal system. Here are a few binary/decimal equivalents:

<u>BINARY</u>	<u>DECIMAL</u>
0000000000000000	0
0000000000000001	1
0000000000000010	2
0000000000000100	4
0000000000001000	8
1111111111111111	65,535

Figure A. Binary numbers and their decimal equivalents

Each digit in the number is called a *bit*, so the numbers in *Figure A* are sixteen bits long, and the maximum value which can be represented is 65,535.

Sample Size

The more bits that are used to store the sampled value, the more closely it will represent the source signal. In an 8-bit system, there are 256 possible combinations of zeroes and ones, so 256 different analog voltages can be represented. A 16-bit system provides 65,535 possible combinations. A 16-bit signal is capable of providing far greater accuracy than an 8-bit signal. *Figure B* shows how this works.

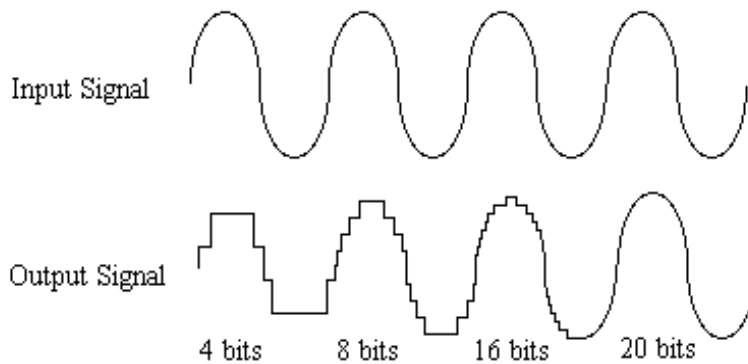

Figure B. The more bits there are available, the more accurate the representation of the signal and the greater the dynamic range.

Mona's analog inputs use 24-bit ADCs, which means that the incoming signal can be represented by any of over 16 million possible values. The output DACs are also 24-bit; again, over 16 million values are possible. The S/PDIF inputs and outputs also support signals with up to 24-bit resolution. Mona processes signals internally with 24-bit resolution to insure that there is no degradation to the audio signal as it is processed through the system.

The number of bits available also determines the potential dynamic range. Moving a binary number one space to the left multiplies the value by two (just as moving a decimal number one space to the left multiplies the value by ten), so each additional bit doubles the maximum value that may be represented. Each available bit provides 6dB (see decibel section below) of dynamic range. For example, a 24-bit system can theoretically provide 144dB of dynamic range.

Sample Rate

The rate at which the ADC generates the numbers is equally important in determining the quality of a digital recording. To get a high level of accuracy when sampling, the sample rate must be greater than twice the frequency being sampled. The mathematical statement of this is called the Nyquist Theorem. When dealing with full-bandwidth sound (20Hz–20kHz), you should sample at greater than 40,000 times per second (twice 20kHz). Mona allows you to sample at rates up to 96,000 times per second.

If the sampling rate is lower than the frequency you are trying to record, entire cycles of the waveform will be missed, and the result will not resemble the proper waveform. When the sample rate is too low, the resulting sound has diminished high frequency content.

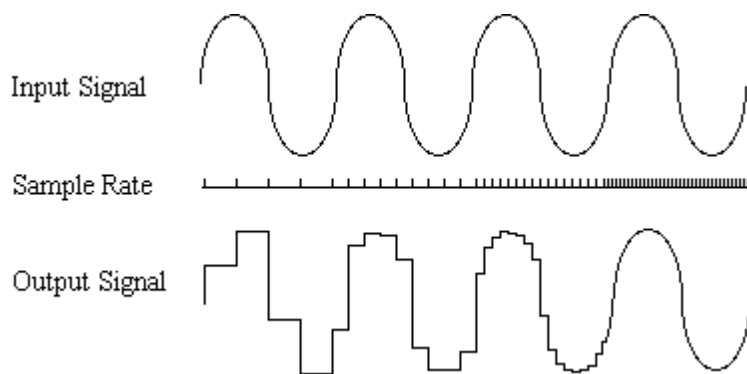

Figure C. Increased sample rates yield a more accurate reproduction of the source signal.

By the way, the circuits that generate the sample rate must be exceedingly accurate. Any difference between the sample rate used for recording and the rate used at playback will change the pitch of the recording, just as with an analog tape playing at the wrong speed. Also, any unsteadiness, or jitter, in the sample clock will distort the signal as it is being converted from or to analog form.

Storing Digital Data

Once the waveform has been transformed into digital bits, it must be stored. When sampling in stereo at 48kHz using a 20-bit word size, the system has to accommodate 1,920,000 bits per second. Though this is a lot of data, it is well within the capabilities of personal computers.

Most computer-based digital recording systems record the data directly to the computer's hard disk. Today's hard disks are capable of storing large amounts of data, though the performance of hard drives can vary substantially. The speed and size of your hard drive will be a major determining factor in how many tracks of audio you will be able to simultaneously record and playback.

Decibels

Audio signal levels are generally expressed in units called "decibels" which are abbreviated as "dB". This is a "logarithmic" scale where each doubling of signal level is represented by an increase of 6dB. Therefore a signal of 6dB is twice as big as a 0dB signal and a signal of 12dB is four times as big as a 0dB signal.

Since digital audio signals are represented by binary data, each bit of audio information represents 6dB. A 16-bit number can represent a total range of 96dB and a 24-bit number can represent a total range of 144dB (6 times the number of bits). It's much easier to say that one signal is 72dB less than another instead of saying it is 1/4096 the size of the other one. It also more accurately represents the way we hear sounds, since the smaller signal in the above example will still be audible and not appear to be only 1/4096 as loud when we listen to it.

Just as there are different types of degrees used to represent temperature (Fahrenheit, Celsius, etc), there are different types of decibels used to represent the level of analog audio signals. The most common are dBu and dBV decibels. Both of these represent voltage levels and still double for every increase of 6dB. It is only the reference point, or 0dB level that is different. A 0dBV signal has a voltage level of 1.0 volts. A 0dBu signal has a voltage level of .775 volts. Since .775 is approximately 2dB less than

1.0, converting dBV levels into dBu levels is as simple as subtracting 2dB (2.21 to be exact).

Signals are also occasionally represented with units of dBm. This is an older unit that measures power instead of voltage levels with 0dBm representing 1 milliwatt. Earlier tube-based audio equipment used standardized input and output impedances of 600 ohms, so a 0dBm signal was produced with a voltage of .775 volts. Since most of today's equipment uses impedances other than 600 ohms, it is more useful to represent signals by voltages rather than power and the dBu unit was introduced. A signal level of 0dBu is identical to a level of 0dBm.

Digital signals, after they are recorded, no longer directly represent any physical quantity such as voltage or power and 0dB is generally used to represent a "full-scale" or maximum signal level. All other signal levels are lower and are expressed as negative decibels. Most meters on digital equipment have 0dB at the top and range downward from there. A signal that is 30dB below full scale would simply be referred to as a -30dB signal.

Nominal Signal Levels and Headroom

Today's equipment is generally referred to as +4dBu equipment (professional) or -10dBV equipment (consumer). These levels are the typical or "nominal" signal levels you can expect to see with professional (studio) equipment such as mixers or with consumer equipment such as home stereos and CD players. A +4dBu signal has a voltage level of 1.23 volts and a -10dBV signal has a voltage level of .316 volts.

The above nominal levels represent typical or average levels that are often exceeded when recording loud signals such as drum beats. The difference between the nominal level and the loudest signal that can be recorded without clipping is called "headroom". Mona provides approximately 18dB of headroom allowing a 22dBu signal (9.8 volts or 28 volts peak to peak) to be recorded. Of course, increasing the gain with the trim knob will allow you to manually adjust the headroom for softer signals

Unbalanced and Balanced Inputs and Outputs

An unbalanced signal, commonly used for guitars and consumer electronics, contains two components, a ground signal and a “hot” or active signal. The ground is the barrel of a ¼” connector and the shell of an “RCA” style connector.

A balanced signal contains two active signals instead of one in addition to the ground. These are referred to as the “plus” and “minus” signals. A balanced input amplifier amplifies the difference between these two signals. Any extraneous noise picked up from power lines or other sources will appear equally on both the plus and minus inputs. This is called “common mode” noise since it is common to both signals and the input amplifier will subtract the noise on the minus input from the noise on the plus input.

If the input amplifier is perfectly balanced and the noise on both plus and minus is precisely equal, the noise will completely cancel out. In the real world this is not the case and some of the common mode noise will still make it through, although at a much reduced level. How well an input amplifier rejects this common mode noise is called the “common mode rejection ratio” (abbreviated as CMRR) and is expressed in dB.

Balanced signals connect with either XLR connectors or TRS (tip, ring sleeve) connectors. Mona uses XLR connectors for connecting microphones and TRS connectors for connecting balanced line level signals.

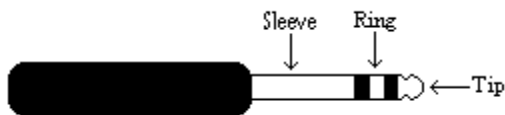

The three sections of a TRS connector are used to transmit the three components of a balanced signal (T = plus, R = minus, S = ground). Mona can also accommodate the two conductor unbalanced style connector.

Dynamic Range

Dynamic range represents the difference between the maximum signal that can be recorded and the “noise floor”, or level of noise with no signal present. A system with a high dynamic range will be quieter than one with a lower dynamic range. Dynamic range is a very important specification and Mona uses converters that have very high dynamic range.

Theoretically, a 24-bit system has a dynamic range of 144dB and a 16-bit system has a dynamic range of 96dB. Two questions immediately come to mind:

- 1) Why does Mona only have a dynamic range of 110 to 115dB?
- 2) For mastering 16-bit CDs with a dynamic range of 96dB, isn't anything more than 96dB just overkill?

First, today's analog to digital converters typically produce a full-scale input voltage with an input of +7dBu. If they were to have 144dB of dynamic range, they would have to be capable of resolving signals as small as – 137dBu (7dBu – 144dBu) or approximately 10 nano-volts. That's 10 *one-billionths* of a volt! Transistors and resistors produce noise in this range just by having electrons moving around due to heat. Even if the converters could be perfectly designed to read these levels, the low noise requirements of the surrounding circuitry such as power supplies and amplifiers would be so stringent that they would either be impossible or too expensive to build.

In answering the second question, consider the fact that music is often compressed or amplified after it is recorded, and that some headroom is necessary when recording to avoid clipping. The only way that 96dB would be adequate is if all music were recorded so that the peaks were just under full-scale and no compressing or amplification was going to be applied after recording. Any time recorded music is amplified, so is the noise at the low end. Mona has enough dynamic range to allow sufficient headroom and post-processing to be applied while still keeping the noise either off the CD completely or down as far as possible.

Appendix D: Specifications

Audio Performance

Analog Inputs (x4):

- Frequency Response: 10Hz – 22kHz, ± 0.25 dB
- Dynamic Range: 110dB A-weighted
- THD+n: $< 0.001\%$, 20Hz–22kHz
- Nominal Input Level: +4dBu
- Maximum Input Level: +22dBu
- Microphone Input Level (balanced XLR):
 - EIN: -129dBV
 - Input Impedance: 1.5K
 - Gain Adjustment: 20 – 60dB
- Line Input Level (balanced TRS):
 - Input Impedance: 10K
 - Gain Adjustment: 0 – 40dB
- Guitar Input (unbalanced 1/4"):
 - Input Impedance: 107K
 - Gain Adjustment: 10 – 50dB

Analog Outputs (x6):

- Frequency Response: 10Hz – 22kHz, ± 0.25 dB
- Dynamic Range: 115dB A-weighted
- THD+n: $< 0.002\%$, 20Hz–22kHz
- +4dBu Outputs (balanced XLR):
 - Nominal Output Level: +4dBu
 - Maximum Output Level: +22dBu

- -10dBV Outputs (RCA):
 - Nominal Output Level: -10dBV
 - Maximum Output Level: +8dBV

Hardware

- Host Interface: PCI bus mastering card
- Four high quality mic preamps with phantom power (+48v)
- Four universal analog inputs with precision 24-bit 128x oversampling analog-to-digital converters
- Six analog outputs (both XLR & RCA) with high performance 24-bit 128x oversampling digital-to-analog converters
- S/PDIF digital I/O with up to 24-bit resolution
- ADAT optical digital I/O
- Trim control and level meter for each analog input
- Headphone output with volume control
- On-board 24-bit Motorola DSP
- 24-bit data resolution maintained throughout entire signal path
- Multiple sample rates from 8kHz to 96kHz
- Word clock I/O
- Esync clock Output

Index

9

96kHz recording, problems · 36

A

ADAT · 11, 16, 26, 27, 28, 36, 38
analog resolution · 41
analog-to-digital converter · 40
ASIO · 8, 20
ASIO 2.0 · 30, 38, 39
ASIO control panel · 32
ASIO driver installation · 20
ASIO software · 38
ASIO software compatibility list ·
38
ASIO tips · 30
audio software · 38

B

balanced · 45
buffer size · 32

C

cables · 12
cd-rom, contents · 6
clock sources and destinations · 24
connectors · 12
consumer mode · 29, 34
consumer output setting · 29, 35
contacting customer service · 33
contents · 6

D

decibels · 43

digital data · 43
digital mode · 11, 23, 31, 38
digital mode switch · 27
digital recording · 40
digital-to-analog converter · 40
Direct Monitoring · 30, 32, 39
driver installation · 18
dynamic range · 46

E

Echo Console · 21
Esync · 10, 26

F

fader · 22

G

G3 · 6
G4 · 6
G4 Cube · 34
guitar input · 14

H

hardware installation · 9
hardware monitoring · 30
headroom · 44

I

iMac · 34
input clock · 24
input levels · 22
inputs, analog · 12
installation · 7
interface box, installing · 12

interface cable · 6
Internal input clock · 26

L

latency · 30, 32
level meters · 14
line input · 13

M

memory · 7
mic preamps · 12
microphone input · 12
monitor controls · 22
multiple Echo cards · 38
multiple Monas · 24
multiple Monas, synchronization ·
26
mute · 22

N

nominal levels · 44

O

optical · 16
Options menu · 29
Options, General · 29
OS X · 34
outputs, analog · 12

P

pan · 22
PCI card, installation · 9
PCI slot · 7
phantom power · 13
processor · 7

processor upgrade card · 7, 34
professional mode · 29, 34
professional output setting · 29, 35

R

rack-mount box, installing · 10
recording, pops or skips · 36

S

S/PDIF · 11, 16, 25, 27, 36, 38
S/PDIF cabling · 11, 17
S/PDIF Consumer · 29
S/PDIF Pro · 29
S/PDIF recording · 34
S/PDIF resolution · 41
sample rate · 40, 42
sample size · 41
SCMS copy-protection · 29, 35
selecting a slot · 9
Show ADAT Controls · 28
software installation · 18
software monitoring · 30
Sound Manager · 8, 34
specifications · 47
static electricity, discharging · 9
synchronization · 24, 25, 35
synchronizing multiple devices · 24
system requirements · 6

T

technical support · 33
trim knob · 14
troubleshooting guide · 34
TRS · 45

U

unbalanced · 45
universal inputs · 12

W

website · 33
word clock · 17, 25

word clock cabling · 17

X

XLR · 12